



KONICA MINOLTA

SPECTROPHOTOMETER CM-2600d

Portable, Compact, Easy to Use
Performs Like a Desktop Spectrophotometer

World's first portable spectrophotometer equipped with automatic
UV adjustment function.

Advanced Numerical UV Control dramatically reduces evaluation time.



The essentials of imaging

The CM-2600d is a portable integrating sphere spectrophotometer designed for versatility in various applications.

Simultaneous measurement of SCI (specular component included) and SCE (specular component excluded). Advanced Numerical Gloss Control.

Simultaneous measurement of SCI and SCE displays data on the LCD in 1.5 seconds. Unlike conventional spectrophotometers, there is no need to switch between SCI and SCE mode. This improves working efficiency, and provides stable measured data since the measurement area does not shift when the mode is switched. And also Relativity Gloss Value can be displayed by using Numerical Gloss Control.



Relativity Gloss Value

The LCD specifications are subject to change without prior notice.

• SCI is a method in which measurements are taken with the specular reflection included. For this reason, it minimizes influences of the surface condition of a sample, and is especially suitable for color quality control and Computer Color Matching.

• SCE is a method in which measurements are taken excluding the specular reflection. For this reason, it provides measurement results similar to those observed by the human eye.



For plastics, paints, resins and consumer products

High reliability and long life. Maintenance-free design.

The number of moving parts used in the instrument is minimized through the introduction of numerical control technology. The CM-2600d can be used with confidence, since it has been developed, manufactured and calibrated to meet ISO 9001 requirements.

*** World's first portable spectrophotometer equipped with instantaneous UV adjustment function. UV evaluation time has been reduced revolutionarily due to the introduction of advanced Numerical UV Control.**

Light sources including and excluding UV component flash sequentially to provide sample data taken with UV-included energy as well as UV-excluded energy (UV400nm cutoff filter)



Example of data taken with UV-excluded energy

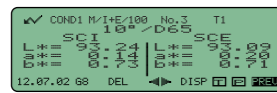

Example of data taken after UV adjustment

* Since the instrument has a built-in instantaneous

UV adjustment function, data can be easily taken using the desired light source (e.g. D65, D50, C). UV calibration can be performed simply by measuring a standard with known fluorescent values under the desired light source.

Once the UV calibration is completed, sample data can be taken by measuring the sample under the desired light source. Since the conventional UV adjustment that requires the UV cutoff filter to be moved is not necessary, measurement time can be reduced drastically.

(Note on UV-Adjustment : Numerical UV-calibration requires for the adjustment calculation SpectraMagic™**NX**.)

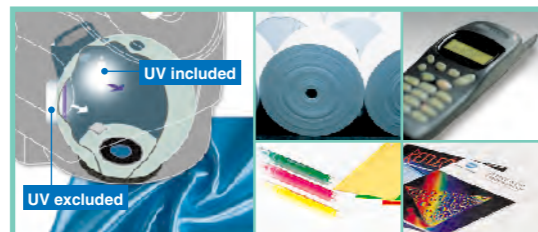

For textile, paper, fluorescent and consumer products

Allows measurement in any position. Compact, lightweight with an easy-to-operate navigation wheel and large LCD display.

The battery-powered small, compact body allows the instrument to be placed in any position at the sample surface.

The large LCD reverse video display provides easy reading, irrespective of which hand it is held in.

Using your finger, the navigation wheel allows simple and user-friendly operation.

(Turn) (Push)



For paints, plastics, automobiles, ceramics, architectural interiors, textile, paper, food etc.

Promotes accurate color communication. Conforms to all widely accepted industry standards and allows measurements in all commonly used color spaces.

The optics use an integrating sphere to provide diffuse illumination/8-degree viewing system.

The CM-2600d conforms to all widely accepted industry standards including ISO, JIS, DIN, CIE and ASTM, and generates measurements in color spaces such as L*a*b*, Yxy, Munsell and CMC.

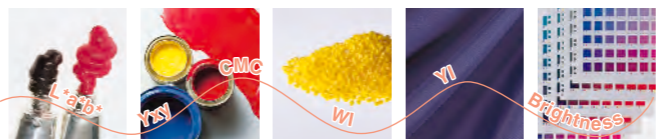

In various applications

Expanded LCD display (64 x 240 dots) Displays a large quantity of information (simultaneous display of SCI and SCE data etc.)

High-accuracy sensor Measures at 10nm intervals for the full wavelength range. Excellent repeatability

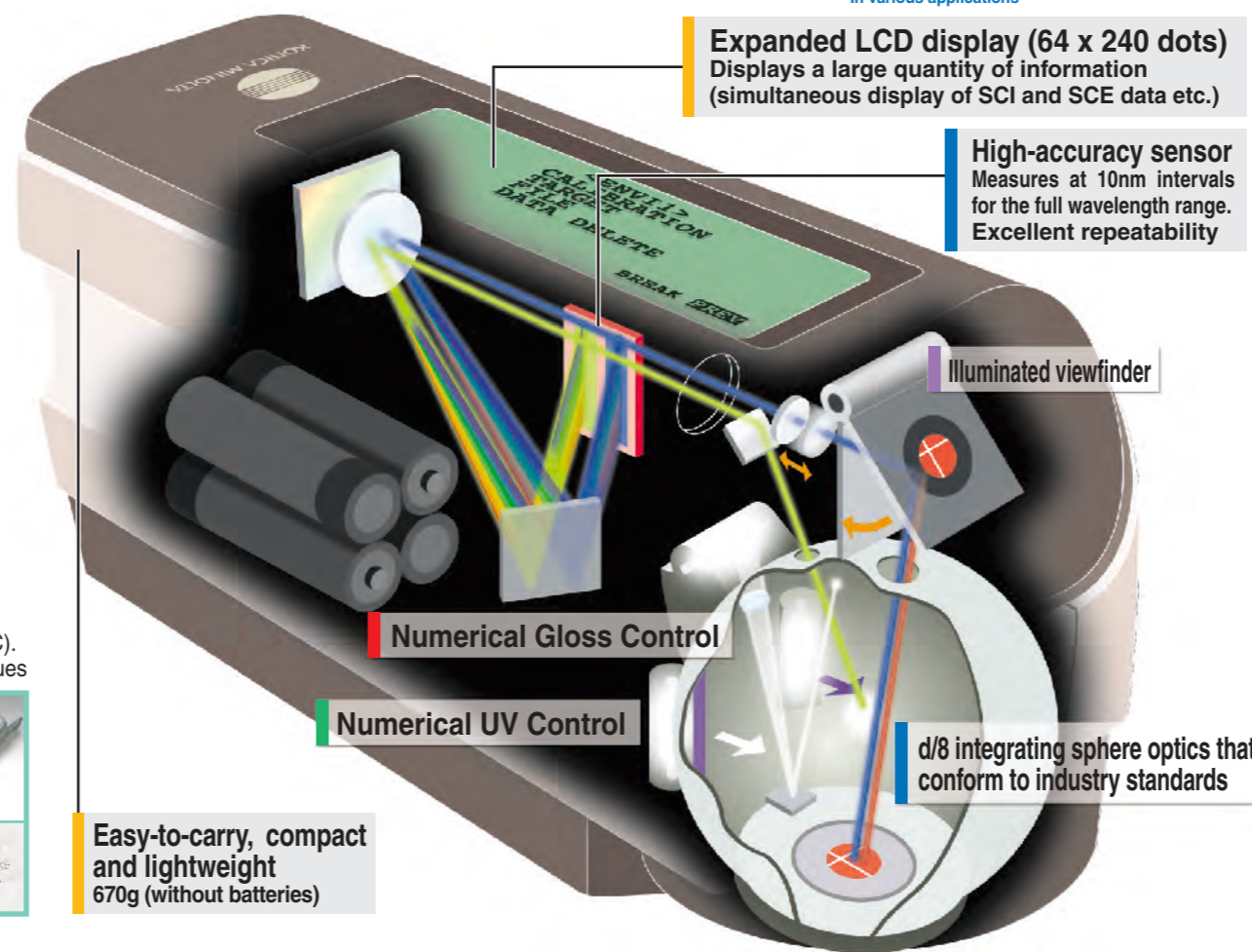

Illuminated viewfinder

Numerical Gloss Control

Numerical UV Control

d/8 integrating sphere optics that conform to industry standards

Easy-to-carry, compact and lightweight 670g (without batteries)

Measures the target with high accuracy. Easy-to-carry stylish body with an illuminated viewfinder.

The instrument is portable and it allows measurements to be taken using two different areas of view (ø8mm and ø3mm). The user can choose the most suitable measurement area for the target. The lightweight, easy-to-carry body with the illuminated viewfinder enables the user to position the instrument on the target quickly and accurately.

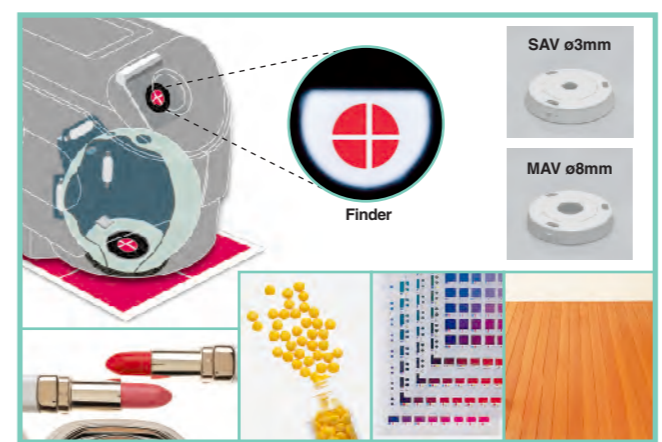

For pharmaceuticals, cosmetics, printing, building materials, textiles etc.

Powerful partnership between CM-2600d and SpectraMagic™**NX**

Color Data Software

SpectraMagic™**NX** (Optional)

Supports Windows®2000/XP

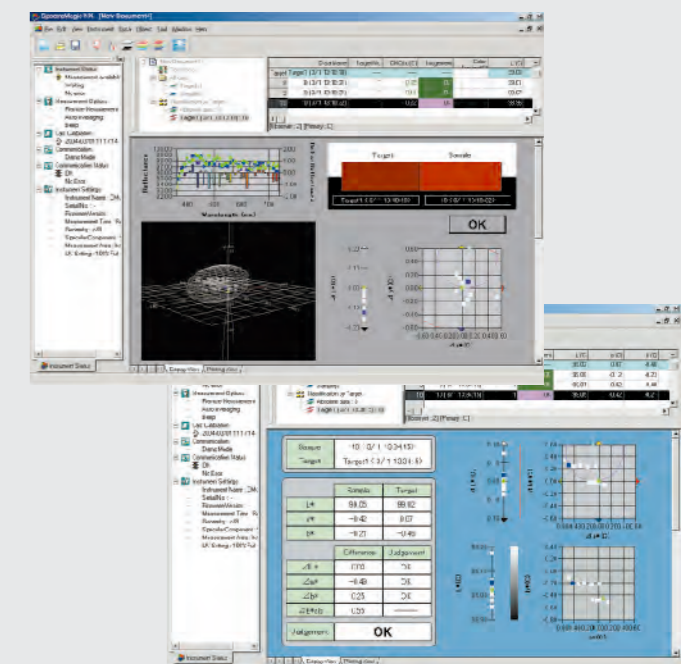
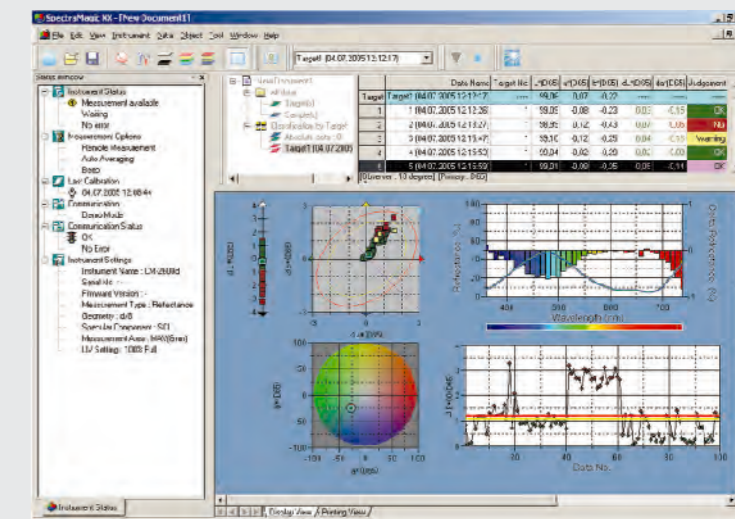

SpectraMagic™**NX** enables you to perform comprehensive color inspection and analysis of incoming raw materials, in process production, and outbound color critical goods and materials in virtually any industry. With SpectraMagic™**NX** you can insert digital images with measured data. Measure samples in any of 8 universally accepted color spaces. Select from 15 illuminants, and up to 40 indices to determine specific color and appearance properties, such as strength, brightness, haze, yellowness, opacity and strength. You can even configure up to 3 customized color equations. Reports range from simple Pass/Fail to trend charts, histograms, color plots, and spectral graphs. SpectraMagic™**NX** comes with predefined templates using skin technology, or you can create your own templates. For illustrations and explanations to understanding color and color measurement technology, there is a link to Konica Minolta's well known and respected "Precise Color Communication". Step by step navigation help. SpectraMagic™**NX** conforms to FDA 21 CFR Part 11 assuring integrity and reliability of data records.

• Windows® is a trademark of Microsoft Corporation in the USA and other countries.

Specifications	
Illumination/ observation system	d/8 (diffuse illumination, 8-degree viewing), equipped with simultaneous measurement of SCI (specular component included)/SCE (specular component excluded) Conforms to CIE No.15,ISO 7724/1,ASTM E1164, DIN 5033 Teil7 and JIS Z8722 Condition C standard.
Sphere Size	ø52mm
Light-receiving element	Silicon photodiode array (dual 40 elements)
Spectral separation device	Diffraction grating
Wavelength range	360nm to 740nm
Wavelength pitch	10nm
Half bandwidth	Approx. 10nm
Reflectance range	0 to 175%, resolution: 0.01%
Light source	3 pulsed xenon lamps
Measurement time	Approx. 1.5 seconds (approx. 2 seconds for fluorescent measurement)
Minimum interval between measurements	3 seconds for SCI/SCE (4 seconds for fluorescent measurement)
Battery performance	Alkaline manganese: approx. 1000 measurements
Measurement/ illumination area	MAV: ø8mm/ø11mm SAV: ø3mm/6mm (Selectable between MAV and SAV)
Repeatability	Spectral Reflectance: Standard deviation within 0.1% (360 to 380nm within 0.2%) Colorimetric Value: Standard deviation within ΔE^*ab 0.04 (Measurement conditions: White calibration plate measured 30 times at 10-second intervals after white calibration was performed)
Inter instrument agreement	within ΔE^*ab 0.2 (MAV/SCI) Average for 12BCRA Series II color tiles compared to values measured with master body.
UV adjustment	Instantaneous numerical adjustment (no mechanical adjustment required) With UV400nm cut filter
Measurement mode	Single measurement/automatic averaging of multiple measurements (auto mode: 3, 5, 8 times/manual mode)
Interface	RS-232C standard
Observer	2/10 degrees (CIE 1931/2°, CIE 1964/10°)
Illuminant	A, C, D50, D65, F2, F6, F7, F8, F10, F11, F12 (simultaneous evaluation is possible using two light sources)
Display data	Spectral value/graph, colorimetric value, color difference value/graph, PASS/FAIL result
Color space/ colorimetric data	L*a*b*, L*C*h, CMC (1:1), CMC (2:1), CIE94, Hunter Lab, Yxy, Munsell, XYZ, MI, WI (ASTM E313), YI (ASTM E313/ASTM D1925), ISO Brightness (ISO 2470), Density status A/T, WI/Tint (CIE/Ganz), CIE00
Data memory	1700 pieces of data (as SCI/SCE 1 data) * 700 pieces of data in the " defined in COND." mode. * Total of the sample data for the COND and TASK modes and color difference target data
Tolerance judgment	Tolerance for color difference (both box and elliptical tolerances can be set)
Power source	4 AA-size battery or AC adapter
Size (WxHxD)	69 x 96 x 193mm
Weight	Approx. 670g (without batteries)
Operating temperature/ humidity range (*1)	5 to 40°C, relative humidity 80% or less (at 35°C) with no condensation
Storage temperature/ humidity range	0 to 45°C, relative humidity 80% or less (at 35°C) with no condensation
Standard accessories	White calibration plate, Target mask ø8mm, Target mask ø3mm, RS-232C cable, AC adapter, AA-size battery (x4)
Optional Accessories	Hard case, Dust cover set, Dust cover, SpectraMagic™NX (software), Zero calibration box

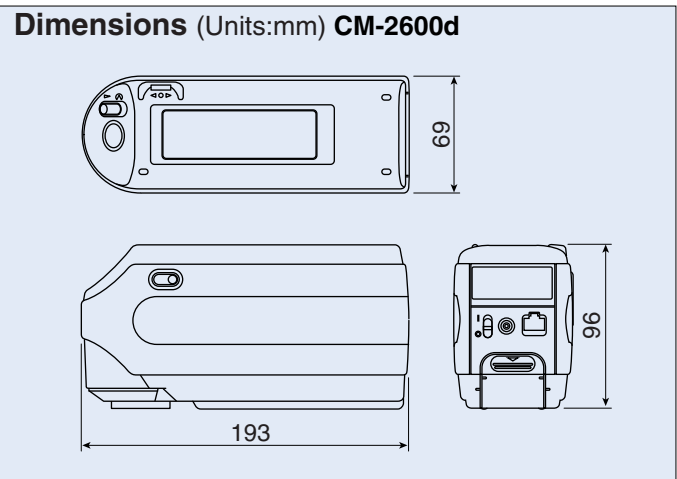
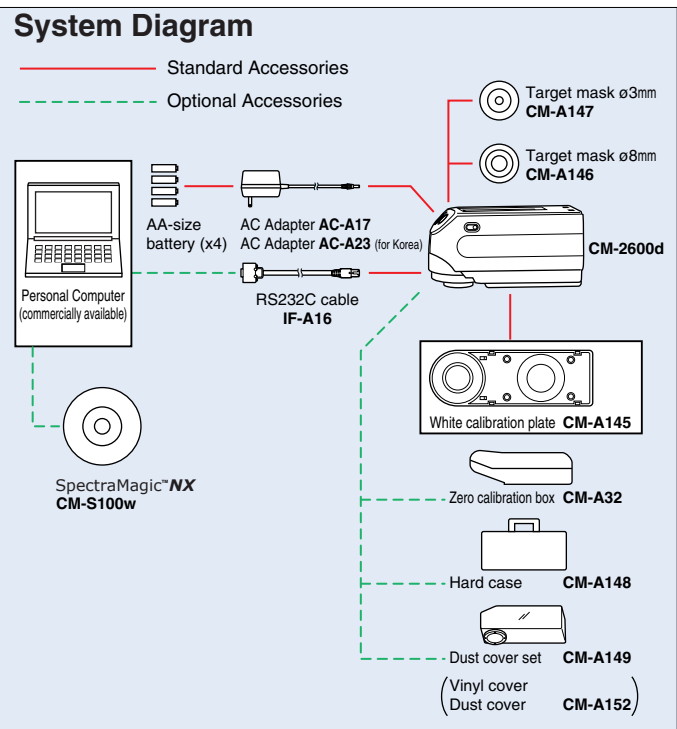

*1 Operating temperature/humidity range of products for North America : 5 to 40°C, relative humidity 80% or less (at 31°C) with no condensation

Color control network by spectrophotometer

High inter-instrument agreement between the portable CM-2600d spectrophotometer and the desk top CM-3000 series make it easy to build a total color control network.

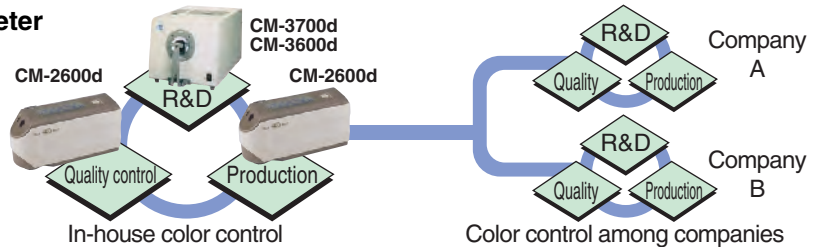

SAFETY PRECAUTIONS

For correct use and for your safety, be sure to read the instruction manual before using the instrument.



- Always connect the instrument to the specified power supply voltage. Improper connection may cause a fire or electric shock.
- Be sure to use the specified batteries. Using improper batteries may cause a fire or electric shock.



Certificate No : YKA 0937154
Registration Date : March 3, 1995



Certificate No : JQA-E-80027
Registration Date : March 12, 1997

* The specifications and drawings given here are subject to change without prior notice.

KONICA MINOLTA SENSING, INC.
Konica Minolta Sensing Americas, Inc
Konica Minolta Sensing Europe B.V.

Osaka, Japan
New Jersey, U.S.A.
European Headquarter /BENELUX
German Office (International)
German Office (Germany)
French Office
UK Office
Italian Office
Swiss Office
Nordic Office
Austrian Office
Polish Office

Konica Minolta (CHINA) Investment Ltd.
SE Sales Division
SE Beijing Office
SE Guangzhou Office

Konica Minolta Sensing Singapore Pte Ltd.

KONICA MINOLTA SENSING, INC. Seoul Office

Phone : 888-473-2656(in USA), 201-236-4300(outside USA)

Nieuwegein, Netherland
Langenhagen, Germany
München, Germany
Roissy CDG, France
Milton Keynes, United Kingdom
Milan, Italy
Dietikon, Switzerland
Västra Frölunda, Sweden
Wien, Austria
Warszawa, Poland

Shanghai, China
Beijing, China
Guangzhou, China
Singapore
Seoul, Korea

Phone : +31(0)30 248-1200
Phone : +49(0)511 7404-862
Phone : +49(0)89 630267-20
Phone : +33(0)1 493-82519
Phone : +44(0)1908 540-622
Phone : +39(0)23 90111
Phone : +41(0)43 322-9800
Phone : +46(0)31 7099464
Phone : +43(0)1 87882-430
Phone : +48(0)22 56033-00

Phone : +86-021-5489 0202
Phone : +86-010-8522 1551
Phone : +86-020-3826 4220
Phone : +65 6563-5533
Phone : 02-523-9726

Fax : 201-785-2480

Fax : +31(0)30 248-1211
Fax : +49(0)511 7404-807
Fax : +49(0)89 630267-67
Fax : +33(0)1 493-84771
Fax : +44(0)1908 540-629
Fax : +39(0)23 9011219
Fax : +41(0)43 322-9809
Fax : +46(0)31 474945
Fax : +43(0)1 87882-431
Fax : +48(0)22 56033-01

Fax : +86-021-5489 0005
Fax : +86-010-8522 1241
Fax : +86-020-3826 4223
Fax : +65 6560-9721
Fax : 02-523-9729

Addresses and telephone/fax numbers are subject to change without notice. For the latest contact information, please refer to the KONICA MINOLTA SENSING Worldwide Offices web page (link below).

©2001 KONICA MINOLTA SENSING, INC.

<http://konicaminolta.com/about/se/contact.html>

9242-4879-11 AGMGPK® Printed in Japan